

Ventilatiekanalen, hulpstukken rond

Zadelstuk 90°

Maatschetsen
Materiaal
Bedrijfsdruk

1024684
PPs
+/- 1500 Pa, 40°C

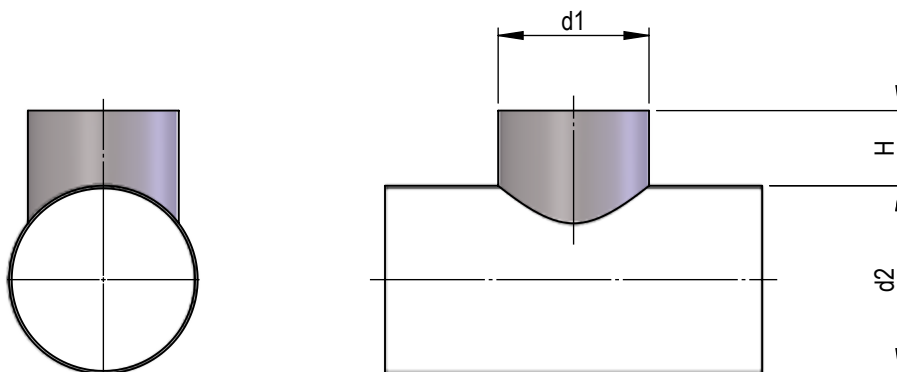

NG1	NG2	H	Artikelnr.
50	≤50	100	38860
63	≤63	100	19024
75	≤75	100	19189
90	≤90	100	19190
110	≤110	100	19191
125	≤125	100	19192
140	≤140	100	19193
160	≤160	100	19194
180	≤180	100	19195
200	≤200	100	19196
225	≤225	100	19197
250	≤250	100	19198
280	≤280	100	19199
315	≤315	100	19200
355	≤355	100	19201
400	≤400	100	19202
450	≤450	100	19203
500	≤500	100	19204
560	≤560	100	19205
630	≤630	100	19206
710	≤710	100	19207
800	≤800	100	19208
900	≤900	100	19209
1000	≤1000	100	19210
1120	≤1120	100	19211
1250	≤1250	100	19212

Edite 2026 • Wijzigingen voorbehouden • Copyright by COLASIT AG Spiez

COLASIT Holland B.V.
Kunststof apparatenbouw • Larenweg 56 • NL-5234 KC 's-Hertogenbosch
Tel. +31 (0)73 641 83 15 • verkoop@colasit.nl
www.colasit.nl

Competence in plastics. Worldwide.

